

BARTLETT BLUFF

Plan Pricing

AYDEN

1.5 Story Floor Plan

2,831 Sq Ft

\$449,900

4 Bedroom, 3 Bathrooms w/ Main Level Master, Covered Porch, & Loft

Floor Plan Options include Side Entry Garage, Extended Garage, Screen Porch, Sunroom, Dormer & Elevation Options

LEDFORD II

1.5 Story Floor Plan

2,495 Sq Ft

\$419,900

4 Bedroom, 2.5 Bathrooms w/ Main Level Master, Upstairs Loft & Bonus Room

Floor Plan Options include Side Entry Garage & Screen Porch



SIMPLY BUILT BETTER.



BERKSHIRE HATHAWAY | Carolinas Realty
HomeServices

We are constantly improving our homes. Arden Homes reserves the right to revise and/or substitute features, square footage, dimensions, specifications, architectural details, designs and pricing without notice.

Amanda Heath
336-682-6822 | AmandaHeathHomes@gmail.com



BARTLETT BLUFF

Standard Selections

Exterior Finishes

- **Garage Door** – Amarr® – Hillcrest 1000 w/ Blue Ridge Hardware
- **Foundation** – Brick Raised Slab – *Heritage Bridge, Oak Crest, Roller Mill = Crawl Space
- **Deck** – Raised Patio
- **Roofing** – GAF Timberline® – 30 Year – Architectural
- **Windows** – Ply Gem 1500® – Single Hung Vinyl – Low E, Argon Filled (white, clay, or beige)
- **Front Door** – 6 Panel Fir
- **Stone Veneer** – Centurion Stone® – Choice of Style/Color (Per Plan)
- **Veneer Material** – Pine Hall Brick
- **Board & Batten** – Vinyl (Per Plan)
- **Shakes** – Vinyl – Foundry – Traditional or Weathered Collection (Per Plan)
- **Shutters** – Vinyl
- **Mailbox** – Decorative Mailbox
- **Porch Ceilings** – D5 Vinyl
- **Soffits** – D5 Vinyl

Plumbing

- **Lavatory Fixtures** – Moen® – Eva or Brantford – Chrome
- **Kitchen Sink Fixture** – Moen® – Brantford 7581C – Chrome
- **Tub/Shower Fixture** – Moen® – Eva or Brantford – Chrome
- **Garden Tub Fixture** – Moen® – Eva or Brantford – Chrome
- **Water Heater** – American® 50 Gallon Gas Direct Vent (*Some Plans may call for Electric)
- **Pedestal Sink** (Per Plan) – Gerber® – Logan Square (22-555)
- **Water Closets** – Mansfield® – Elongated Standard Height – White
- **Water Lines** – Pex Water Lines
- **Kitchen Sink** – 18 Gauge Stainless Steel w/ Choice of: 50/50 Two Bowl or 60/40 Two Bowl
- **Master Bathroom Shower** – LVL 1 Ceramic Tile Floors & Walls w/Niche (Shower Size Per Plan)
- **Guest Bath Tub/Shower** – 1 Piece Fiberglass

Heating & Air Conditioning

- **Gas Furnace** – Trane® 80% Gas (Heat Pumps Upstairs in Applicable Plans)
- **Air Conditioning Unit** – Trane® XR16
- **Thermostat** – Honeywell® Digital
- **Ductwork** – Sealed & Tested for Leaks



SIMPLY BUILT BETTER.



BERKSHIRE HATHAWAY | Carolinas Realty
HomeServices



BARTLETT BLUFF

Standard Selections

Electrical/Lighting

- **Interior Light Fixtures** – Progress Lighting® Fixture Package – Madison
- **Exterior Light Fixtures** – Progress Lighting® – Westport
- **Kitchen Island Pendants** – (2) Per Selected Package
- **Switch & Outlet Covers** – Standard – White – No Dimmers
- **Cable Outlets** – 2 in Great Room, 1 Per Guest Bedrooms, 2 in Master Bedroom, and 1 in Loft
- **Ceiling Fans** – Great Room, Master Bedroom, Loft
- **Ceiling Fan Prewires** – Bedrooms
- **Flood Lights** – (2) Buyer Selects Location
- **Can Lights** – Kitchen Ceiling, Over Tubs/Showers as Necessary
- **Wall Conduit** – Installed over Fireplace to Run AV Cables in Wall

Interior Finishes

- **Interior Doors** – Hollow Core w/Choice of Door Style
- **Interior Door Hardware** – Better Home Products® – Noe Valley – Brushed Nickel
- **Front Door Handle Set** – Better Home Products® – Van Ness – Brushed Nickel
- **Cabinets (Kitchen & Baths)** – Level 1
- **Cabinet Hardware** – Richelieu Board – Any Selection
- **Granite Kitchen Countertops** – Granite – Level 1
- **Vanity Bathroom Tops** – Granite – Level 1 w/Undermount White Porcelain Sink Bowls
- **Shower Doors** – Coral® – Full Frame – Brushed Nickel or Chrome – Clear Glass
- **Bath Accessories** – Better Home Products® – Miraloma Park – Brushed Nickel or Chrome
- **Fireplace Mantle** – Richland
- **Fireplace Surround** – Slate
- **Gas Log Set** – Heatilator Caliber 36
- **Ceiling Paint** – Sherwin Williams® – Bright Ceiling White Flat
- **Wall Paint** – Sherwin Williams® – Flat w/Choice of Color
- **Trim Paint** – Sherwin Williams® – White Semi-Gloss
- **Closet Shelving** – Ventilated White Wire
- **Kitchen Backsplash** – LVL 2 – Subway Tile or Tumbled Stone
- **Baseboard** – 5 1/4" Speed Base
- **Door Casing** – 3 1/4" SM445
- **Window Trim** – Stool on Bottom, Drywall Returns w/Casing
- **Crown Molding** – 1 Piece – 3 5/8" #49 – Downstairs and in Master Bedroom



SIMPLY BUILT BETTER.



BERKSHIRE HATHAWAY | Carolinas Realty
HomeServices



BARTLETT BLUFF

Standard Selections

Floor Coverings

- **Engineered Hardwood** (Foyer, Kitchen, Dining, Breakfast, Great Room, Powder, Stairs) – Mohawk – Level 1
- **Ceramic Tile** (Baths, Laundry, & Mud Room) – Daltile – Level 1
- **Carpet** (Bedrooms, Loft, Study) – Mohawk – Top Card® – Level 1
- **Carpet Pad** – 6 lb. – Up 1

Appliances

- **Dishwasher** – Frigidaire – Gallery – FFGID2466QF
- **Disposal** – Badger 1/3 HP
- **Microwave** – Frigidaire – Gallery – FFGMV176NTF
- **Slide In Gas Range** – Frigidaire – Gallery – FFFGS3026TS

“Behind The Walls”

- **Wall Framing** – Primary 2x4 Walls – 2x6 Where Specified on Plans – 16” on Center
- **Floor Joists** – Engineered Wood I-Joists – 19.2” On Center
- **Insulation** – Batt Insulation in Walls, Blown Fiber Glass in Ceilings, Caulked Studs & Electrical Boxes
- **Roof Trusses** – Engineered Pre-Fabricated Wood Trusses
- **Dry Wall** – 1/2” on Walls and Ceilings, 5/8” Fire Rated on Garage Ceilings, 1/2” Mold Resistant around Tubs in Bathrooms



SIMPLY BUILT BETTER.



BERKSHIRE HATHAWAY | Carolinas Realty
HomeServices

We are constantly improving our homes. Arden Homes reserves the right to revise and/or substitute features, square footage, dimensions, specifications, architectural details, designs and pricing without notice.

Amanda Heath
336-682-6822 | AmandaHeathHomes@gmail.com



BARTLETT BLUFF

Ayden



Elevation C



SIMPLY BUILT BETTER.



BERKSHIRE HATHAWAY | Carolinas Realty
HomeServices

We are constantly improving our homes. Arden Homes reserves the right to revise and/or substitute features, square footage, dimensions, specifications, architectural details, designs and pricing without notice.

Amanda Heath
336-682-6822 | AmandaHeathHomes@gmail.com



BARTLETT BLUFF

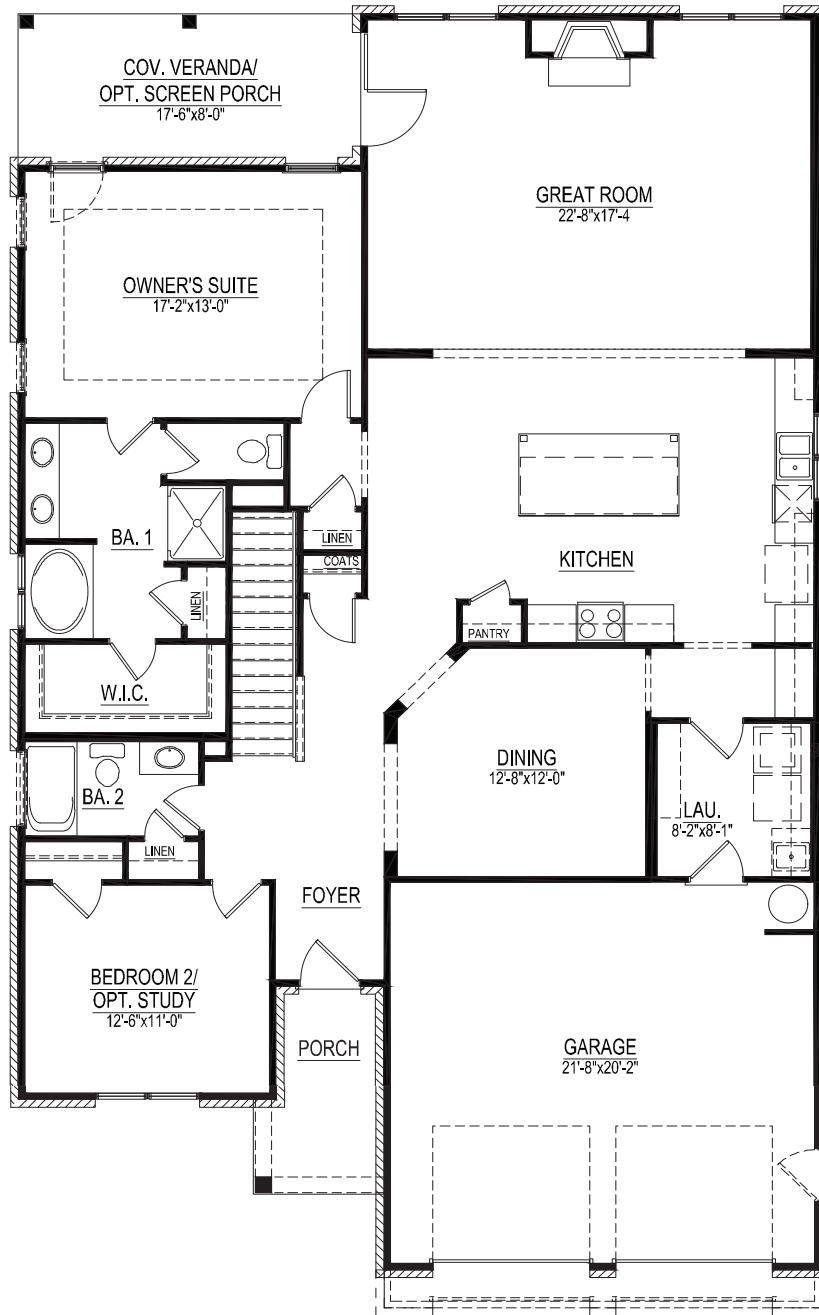

FIRST FLOOR
PLAN



SIMPLY BUILT BETTER.



BERKSHIRE HATHAWAY | Carolinas Realty
HomeServices

We are constantly improving our homes. Arden Homes reserves the right to revise and/or substitute features, square footage, dimensions, specifications, architectural details, designs and pricing without notice.

Amanda Heath
336-682-6822 | AmandaHeathHomes@gmail.com



BARTLETT BLUFF

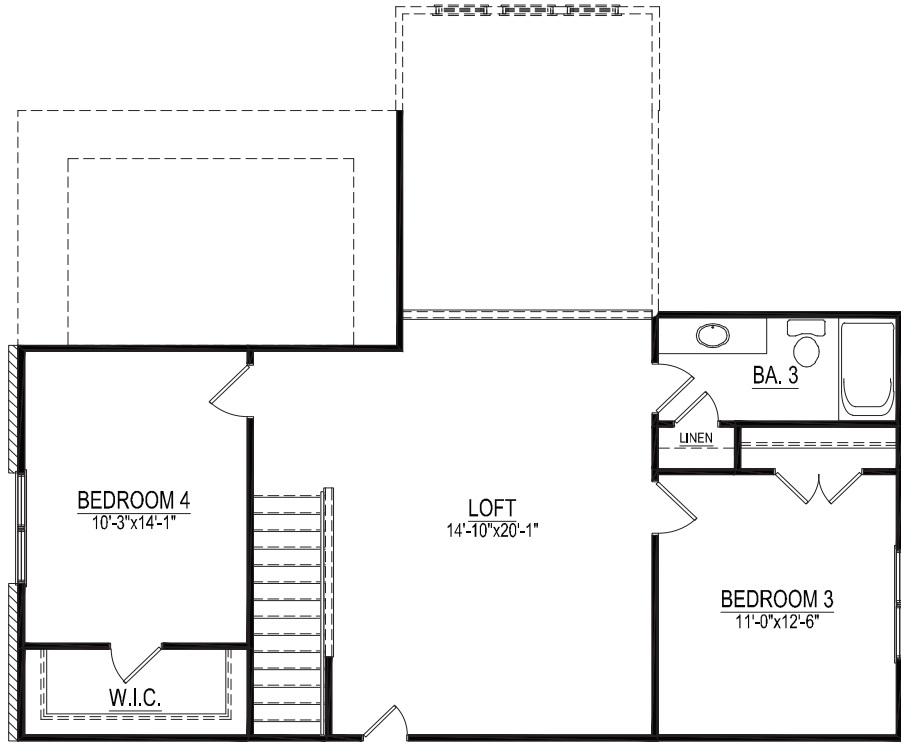

SECOND FLOOR PLAN

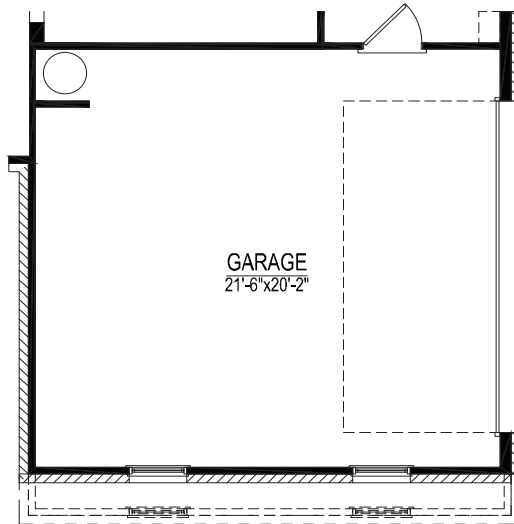

OPT. SIDE-LOAD GARAGE

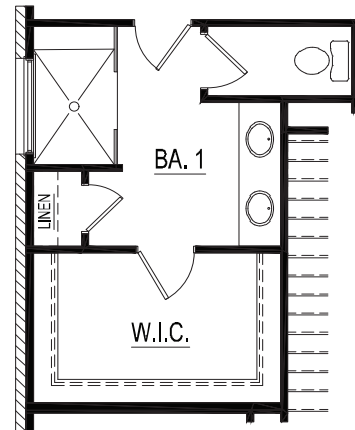

OPT. OWNER BATH



SIMPLY BUILT BETTER.



BERKSHIRE HATHAWAY | Carolinas Realty
HomeServices

We are constantly improving our homes. Arden Homes reserves the right to revise and/or substitute features, square footage, dimensions, specifications, architectural details, designs and pricing without notice.

Amanda Heath
336-682-6822 | AmandaHeathHomes@gmail.com



BARTLETT BLUFF

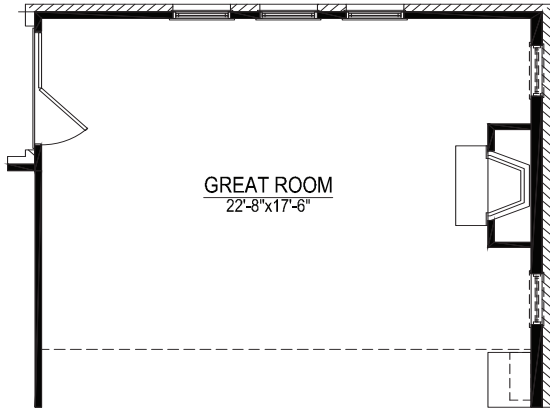

GREAT ROOM
22'-8" x 17'-6"

ALT. FIREPLACE LOCATION

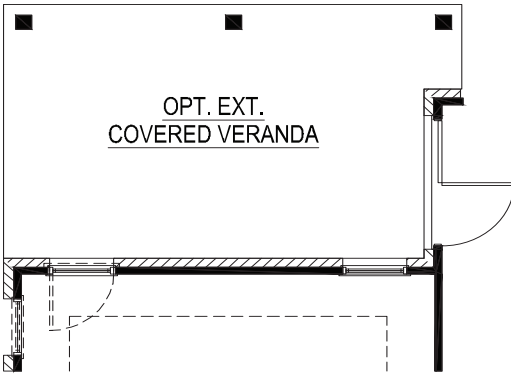

OPT. EXT.
COVERED VERANDA

OPT. EXT. VERANDA

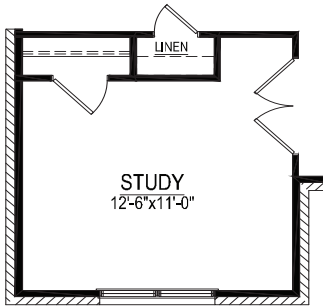

STUDY
12'-6" x 11'-0"

OPT. STUDY

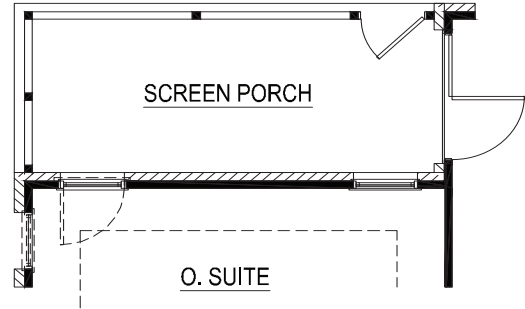

SCREEN PORCH

O. SUITE

OPT. SCREEN PORCH

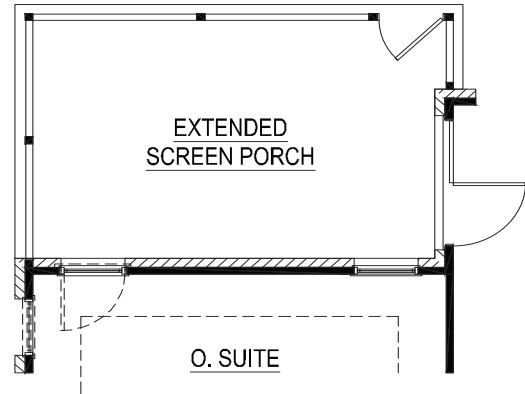

EXTENDED
SCREEN PORCH

O. SUITE

OPT. EXT. SCREEN PORCH

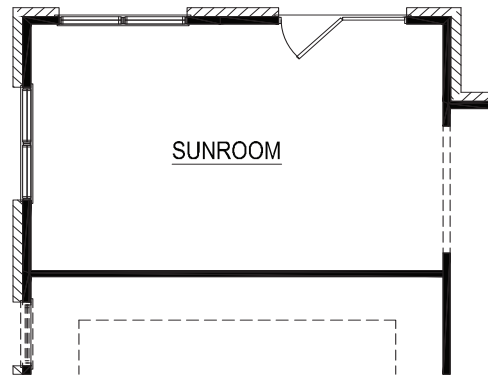

SUNROOM

OPT. SUNROOM
+211 SQFT.



SIMPLY BUILT BETTER.



BERKSHIRE HATHAWAY | Carolinas Realty
HomeServices

We are constantly improving our homes. Arden Homes reserves the right to revise and/or substitute features, square footage, dimensions, specifications, architectural details, designs and pricing without notice.

Amanda Heath
336-682-6822 | AmandaHeathHomes@gmail.com



BARTLETT BLUFF

Ledford II



Elevation C



SIMPLY BUILT BETTER.



BERKSHIRE HATHAWAY | Carolinas Realty
HomeServices

We are constantly improving our homes. Arden Homes reserves the right to revise and/or substitute features, square footage, dimensions, specifications, architectural details, designs and pricing without notice.

Amanda Heath
336-682-6822 | AmandaHeathHomes@gmail.com



BARTLETT BLUFF

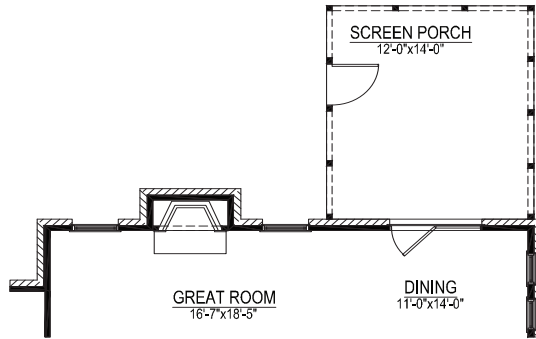

OPTIONAL SCREENED PORCH

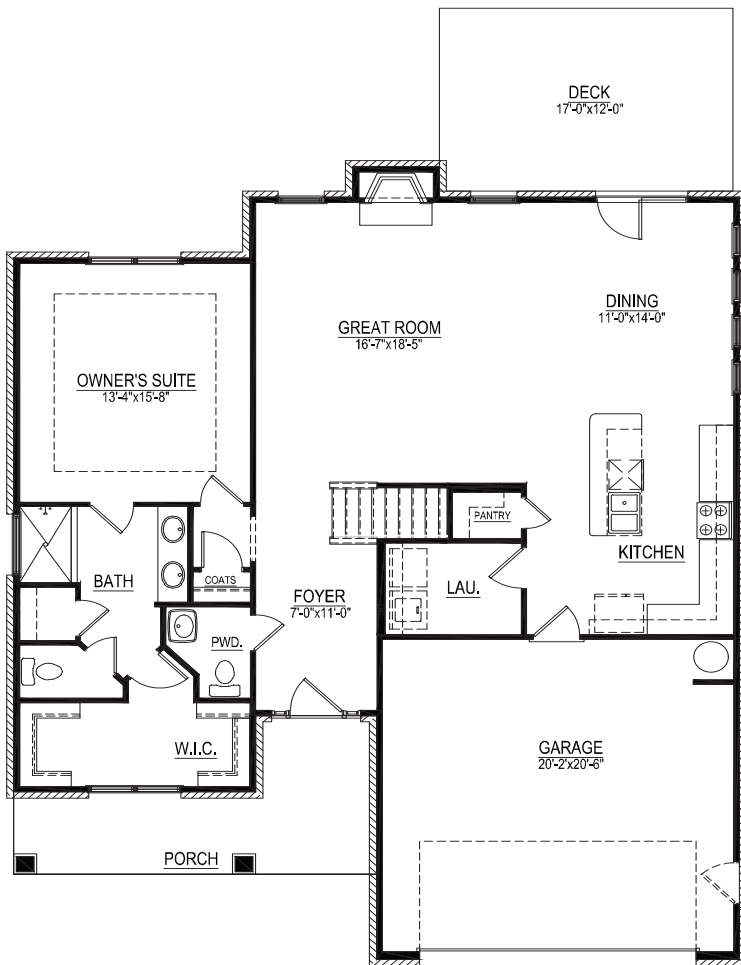

FIRST FLOOR PLAN

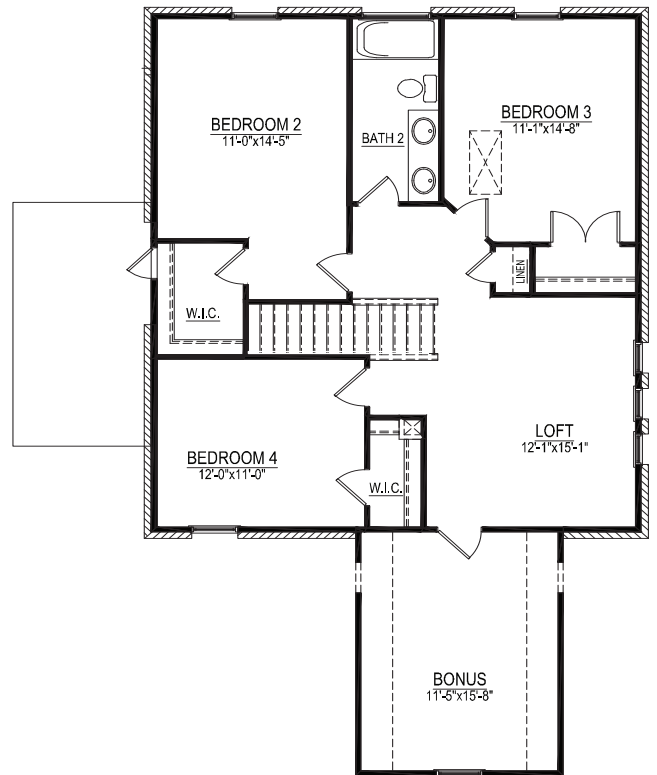

SECOND FLOOR PLAN



SIMPLY BUILT BETTER.



BERKSHIRE HATHAWAY | Carolinas Realty
HomeServices

We are constantly improving our homes. Arden Homes reserves the right to revise and/or substitute features, square footage, dimensions, specifications, architectural details, designs and pricing without notice.

Amanda Heath
336-682-6822 | AmandaHeathHomes@gmail.com



BARTLETT BLUFF

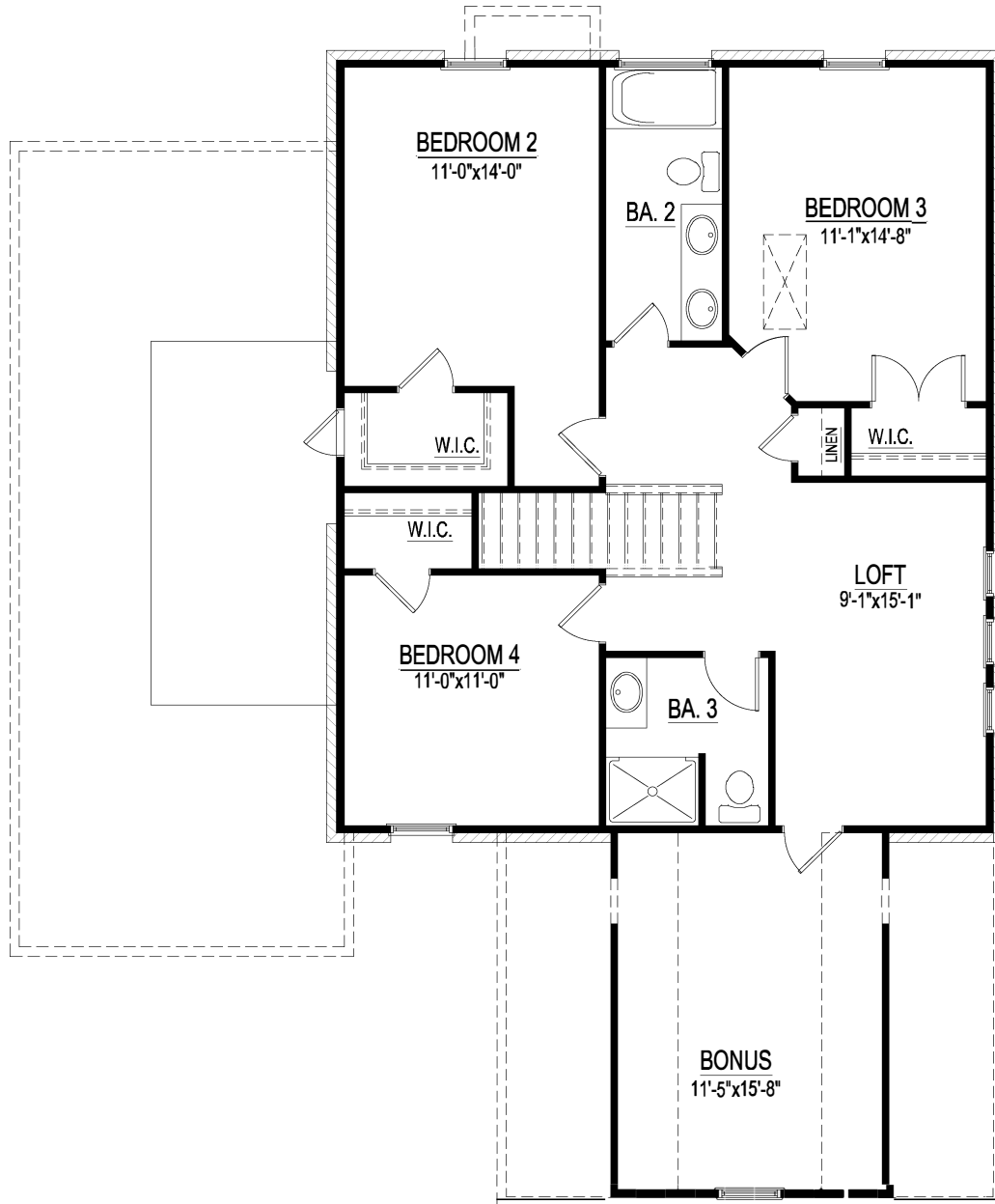

SECOND FLOOR
PLAN W/ OPT. BATH
3



SIMPLY BUILT BETTER.



BERKSHIRE HATHAWAY | Carolinas Realty
HomeServices

We are constantly improving our homes. Arden Homes reserves the right to revise and/or substitute features, square footage, dimensions, specifications, architectural details, designs and pricing without notice.

Amanda Heath
336-682-6822 | AmandaHeathHomes@gmail.com





BARTLETT BLUFF

Legend

- Available Homesite
- Inventory Home
- Model
- Sold
- Under Contract/ Reserved

